

TRANSFORMADORES DE AISLAMIENTO MONOFÁSICOS SINGLE-PHASE ISOLATION TRANSFORMERS

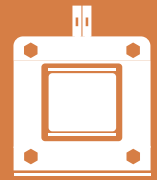

TA SERIES ► 690V / 230Vac

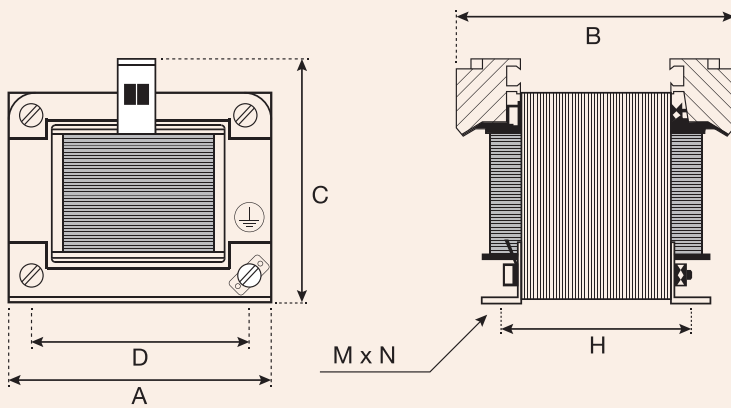

TENSIÓN PRIMARIA / PRIMARY VOLTAGE: 690Vac
TENSIÓN SECUNDARIO / SECONDARY VOLTAGE: 230Vac

Normativa / Standard: **EN-61558-2-4**
Clase de aislamiento / Isolation class: **t₂ 40°C/F**
Rigidez dieléctrica / Dielectric strength:

5000V (Entre primario y secundario / Between primary and secondary)
3500V (Entre primario y masa / Between primary and mass)

Grado de protección / Protection degree: **IP00**
Clase de protección / Protection class: **I**

Frecuencia / Frequencies: **50 / 60Hz**

Conexión / Connection: **Bornas de tornillo-fastón / Screw faston terminals**

Sistema de fijación / Fixing system: **Mediante ángulos DIN 41307 / Through angles DIN 41307**

Bobinado / Winding: **En hilo de cobre clase H. Primario y secundario separado (separación galvánica) / Enamelled copper wire class H. Separated Primary and Secondary (galvanic separation)**

Los transformadores de aislamiento están destinados a alimentar dispositivos eléctricos que necesiten una separación de circuito. Están protegidos contra la humedad mediante impregnación de resina. / Isolation transformers are intended to supply electric devices where a circuit separation is required. Protected against humidity by means of resin impregnation.

► APLICACIONES / APPLICATIONS

Sector renovables / Renewable sector



Sector industrial / Industry sector



Otros sectores / Other sectors



	Potencia / Power (VA)	Código / Code	Dimensiones / Dimensions (mm)						Peso Neto / Net Weight (kg)	Packing / Embalaje
			A	B	C	D	H	MxN		
TA SERIES 600V / 230Vac	40	TA000409700	75	59	95	56	37	9x4,8	0,85	18
	63	TA000639700	84	71	100	64	46	9x4,8	1,39	12
	100	TA001109700	84	80	100	64	57	9x4,8	1,83	12
	160	TA001169700	96	80	108	84	59	11x5,8	2,3	8
	200	TA001209700	96	90	108	84	70	11x5,8	2,84	8
	250	TA001259700	108	91	115	84	69	11x5,8	3,42	8
	315	TA001329700	108	98	115	84	75	11x5,8	3,82	8
	400	TA001409700	120	97	125	90	78	11x5,8	4,8	4
	500	TA001509700	120	116	125	90	90	11x5,8	5,59	4
	630	TA001639700	120	133	125	90	100	11x5,8	6,66	4
	800	TA001809700	150	113	145	122	85	13x7	8,05	2
	1000	TA002109700	150	123	145	122	95	13x7	9,37	2
	1600	TA002169700	150	153	145	122	125	13x7	13,34	2
	2000	TA002209700	150	175	145	122	145	13x7	15,8	2
	2500	TA002259700	195	142	177	150	110	18x10	17,7	1
3000	TA002309700	195	160	177	150	124	18x10	20,56	1	
4000	TA002409700	195	176	177	150	142	18x10	26,13	1	
5000	TA002509700	240	165	260	200	115	27x12	30	1	

Otras potencias y tensiones bajo demanda. / Any other powers and voltages available on request.