

2

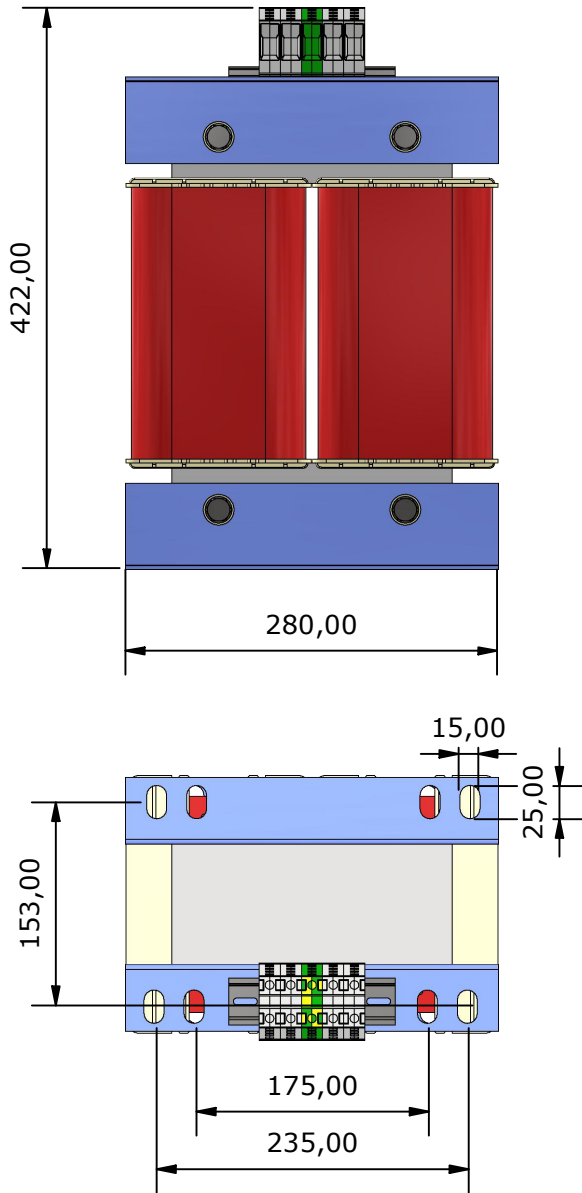

1

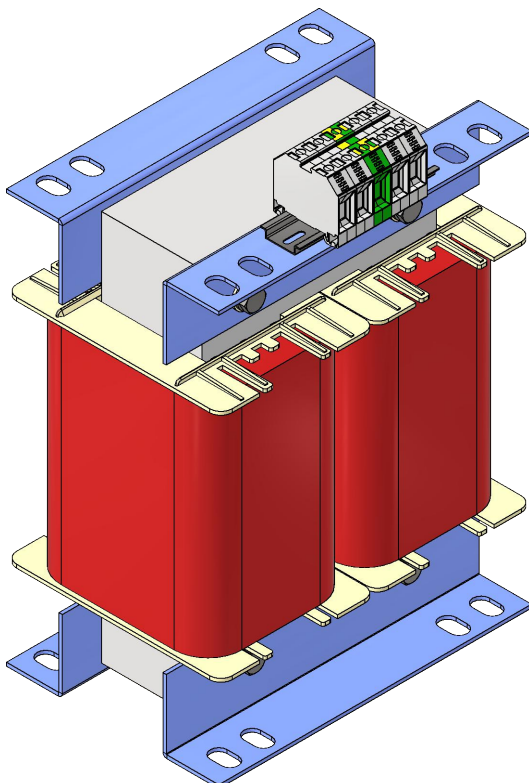
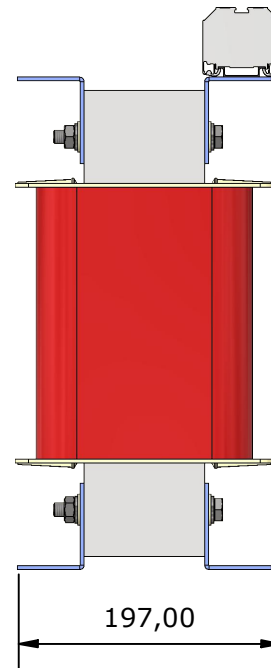

DATOS TECNICOS

Norma	EN-61.558-2-4
Potencia	25000 VA
Tension de entrada	400V
Tension de salida	230V
Frecuencia	50/60 Hz
Grado de proteccion	IP-00
Clase de Aislamiento	F
ED:	100%
Temperatura Ambiente	40°C
Clase	I
Rigidez Dielectrica entre Pri. y Sec.	4.600V
Rigidez Dielectrica entre Pri. y masa	3.500V
Placa caract.	Si
Pantalla Electrostatica	No
Devanados	Hilo Cobre G-2 clase H
Chapa Magnetica	Grano no orientado, laminada en frio. Calidad M 330-50A SEGUN EN10106
Carretes	PA6 + Fibra Vidrio (30%)
Tipo	Seco
Conexion	
Terminales	35mm (PRI) 35mm (SEC)
Peso	79 Kg.

Dibujado por:
Miguel A. Hdez. - 24/10/2022

Aprobado por:
Victor Gallego - 24/10/2022

TRANSFORMADOR MONOFASICO DE
AISLAMIENTO



Units:
mm.

TA003255400

Hoja 1 de 1
Rev: 01
Fecha Rev.: 24/10/2022

MANUMAG SL - C/Antonio Barriendos s/n, Pol. Ind. Las Norias
50450-MUEL, SPAIN - VAT ESB50040146 Tel +34 976 140606 - Fax +34 976 140 607
comercial@manumag.com, export@manumag.com



2

1