

2

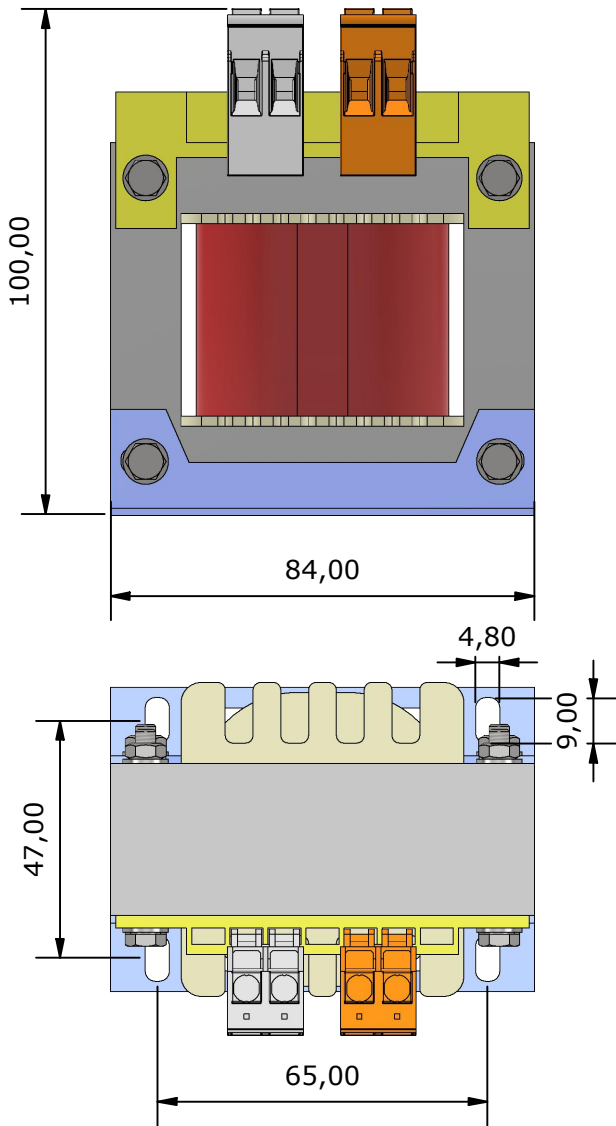

1

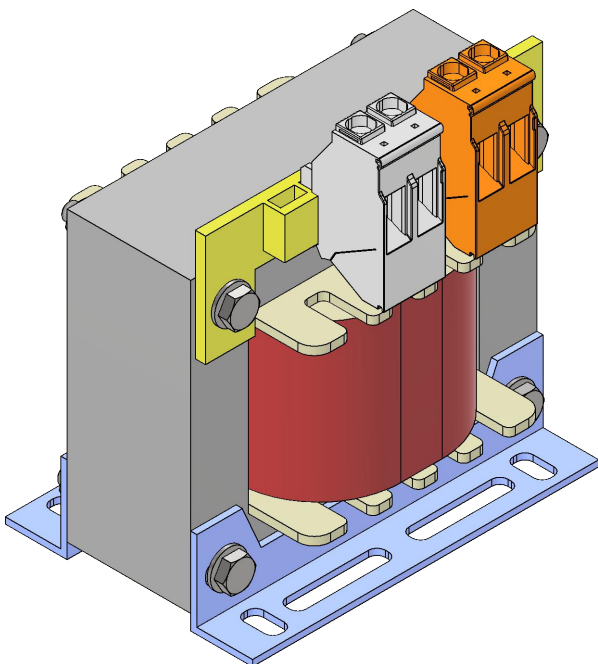
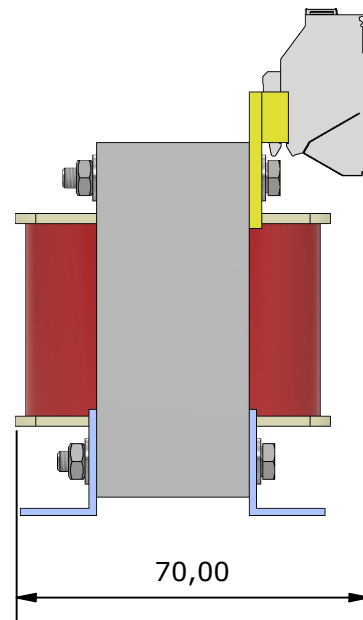

## DATOS TECNICOS

Norma	EN-61.558-2-6
Potencia	75 VA
Tension de entrada	230V
Tension de salida	24V
Frecuencia	50/60 Hz
Grado de proteccion	IP-00
Clase de Aislamiento	F
ED:	100%
Temperatura Ambiente	40°C
Clase	I
Rigidez Dielectrica entre Pri. y Sec.	3.600V
Rigidez Dielectrica entre Pri. y masa	1.800V
Placa caract.	Si
Pantalla Electrostatica	No
Devanados	Hilo Cobre G-2 clase H
Chapa Magnetica	Grano no orientado, laminada en frio. Calidad M 330-50A SEGUN EN10106
Carretes	PA6 + Fibra Vidrio (30%)
Tipo	Seco
Conexion	
Terminales	4mm (PRI) + faston 4mm (SEC) + faston
Peso	1,4 Kg.

Dibujado por:  
Miguel A. Hdez. - 20/09/2022Aprobado por:  
Victor Gallego - 20/09/2022

TRANSFORMADOR MONOFASICO DE SEGURIDAD

Units:  
mm.

TS000753000

Hoja 1 de 1  
Rev: 01  
Fecha Rev.: 20/09/2022MANUMAG SL - C/Antonio Barriendos s/n, Pol. Ind. Las Norias  
50450-MUEL, SPAIN - VAT ESB50040146 Tel +34 976 140606 - Fax +34 976 140 607  
comercial@manumag.com, export@manumag.com

2

1