

2

1

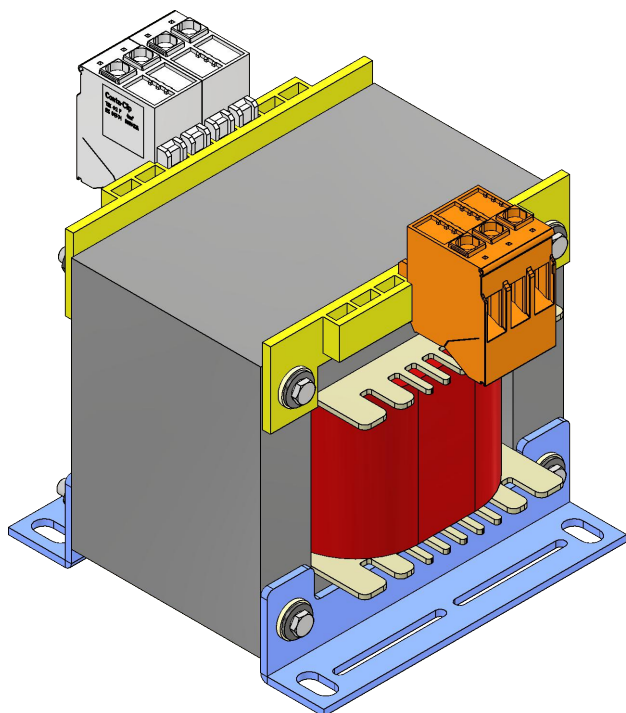
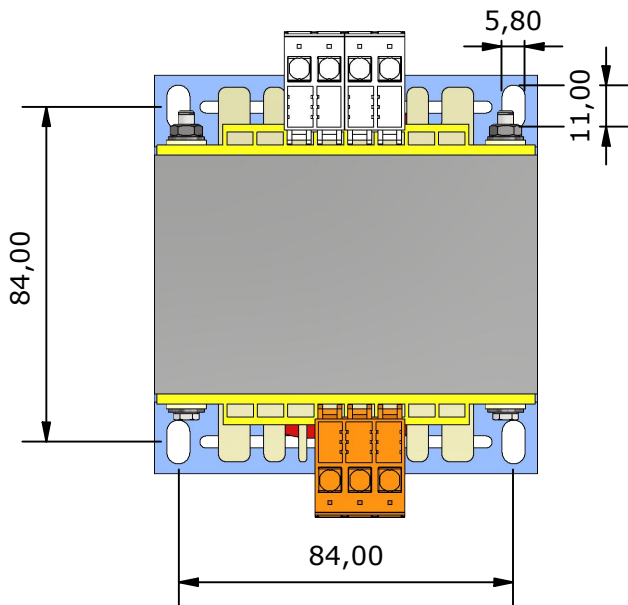
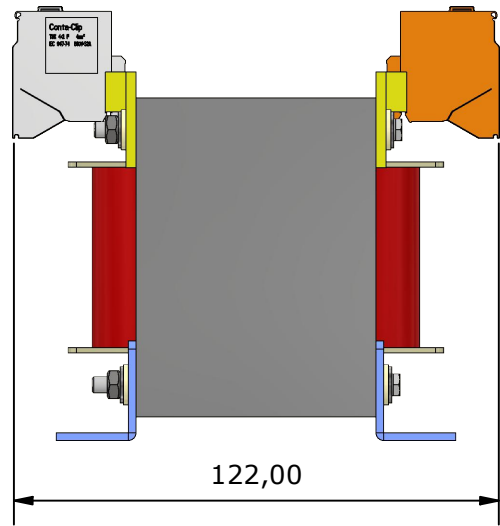
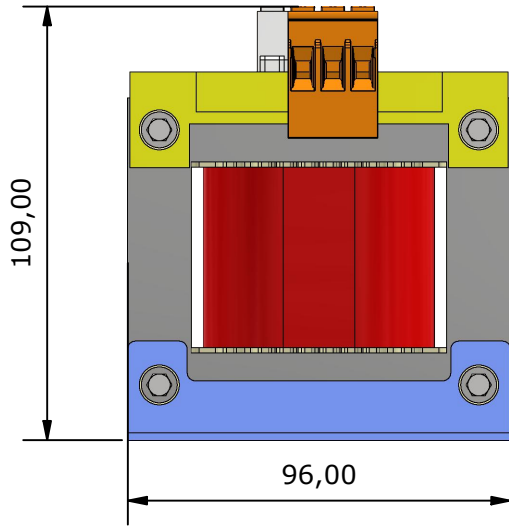

TECHNICAL DATA

According Standard	EN-61.558-2-6
Rated Power	250 VA
Primary Voltage	230/400V
Secondary Voltage	24/48V
Frequency	50/60 Hz
Protection Grade	IP-00
Isolement Level	F
ED:	100%
ta	40°C
Class	I
Strength Dielectric test between live parts	4.600V
Strength Dielectric test between live parts and mass	3.500V
Data Plate	Yes
Electrostatic screen	Non
Wound wires	Cooper wire G-2 class H
Magnetic Core	Non oriented grain, cold lamination. M 330-50A EN10106
Bobbin	PA6 + Glass Fiber (30%)
Type Refrigeration	Dry
Connection	
Terminal block	4mm (PRI) + faston 4mm (SEC) + faston
Weight	3,5 Kg.

Drew by:

Miguel A. Hdez. - 19/09/2022

Approved by:

Victor Gallego - 19/09/2022

SINGLE PHASE SAFETY TRANSFORMER

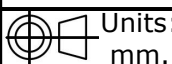

TS041253300

Page 1 de 1
Rev: 01
Rev date.: 19/09/2022

MANUMAG SL - C/Antonio Barriendos s/n, Pol. Ind. Las Norias
50450-MUEL, SPAIN - VAT ESB50040146
Tel +34 976 140606 - Fax +34 976 140 607
comercial@manumag.com, export@manumag.com

2

1