

2

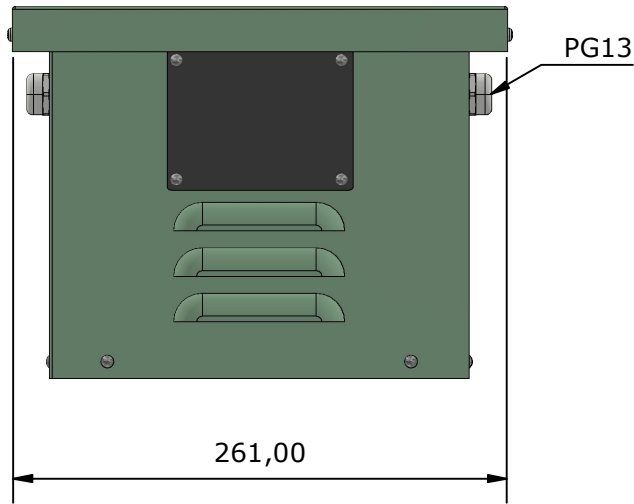

1

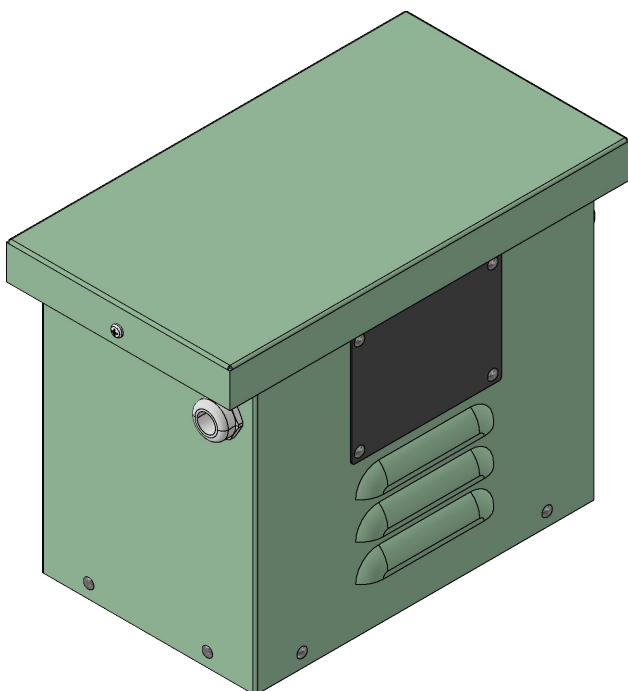
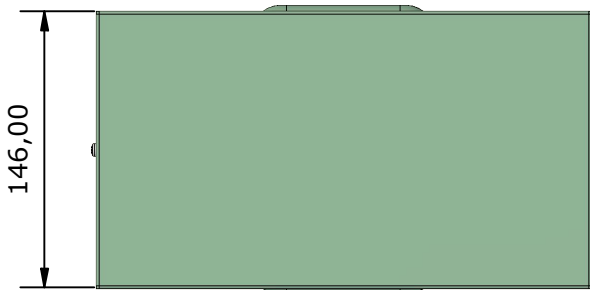
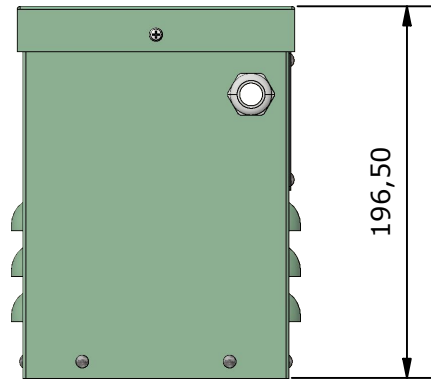

### TECHNICAL DATA

According Standard	EN-61.558-2-13
Rated Power	1 KVA
Primary Voltage	400/690V + N
Secondary Voltage	400/690V + N
Frequency	50/60 Hz
Protection Grade	IP-23
Isolement Level	F
ED:	100%
ta	40°C
Class	I
Strength Dielectric test between live parts	-
Strength Dielectric test between live parts and mass	2.750V
Data Plate	Yes
Electrostatic screen	Non
Wound wires	Aluminum wire G-2 class H
Magnetic Core	Non oriented grain, cold lamination. M 330-50A EN10106
Bobbin	PA6 + Glass Fiber (30%)
Type Refrigeration	Dry
Connection	YN
Terminal block	TEKOX 6mm
Weight	7,2 Kg.

Drew by:

Miguel A. Hdez. - 27/03/2023

Approved by:

Victor Gallego - 27/03/2023

THREE-PHASE AUTOTRANSFORMER

Units:  
mm.

XMN02210963

Page 1 de 1  
Rev: 01  
Rev date.: 27/03/2023

MANUMAG SL - C/Antonio Barriendos s/n, Pol. Ind. Las Norias  
50450-MUEL, SPAIN - VAT ESB50040146  
Tel +34 976 140606 - Fax +34 976 140 607  
comercial@manumag.com, export@manumag.com



2

1