

2

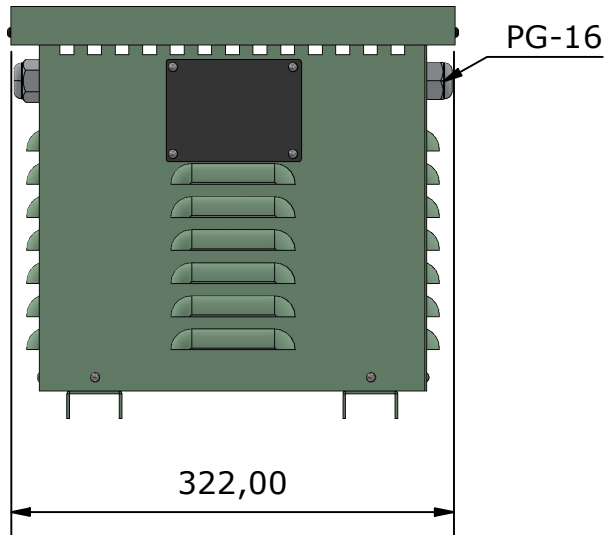

1

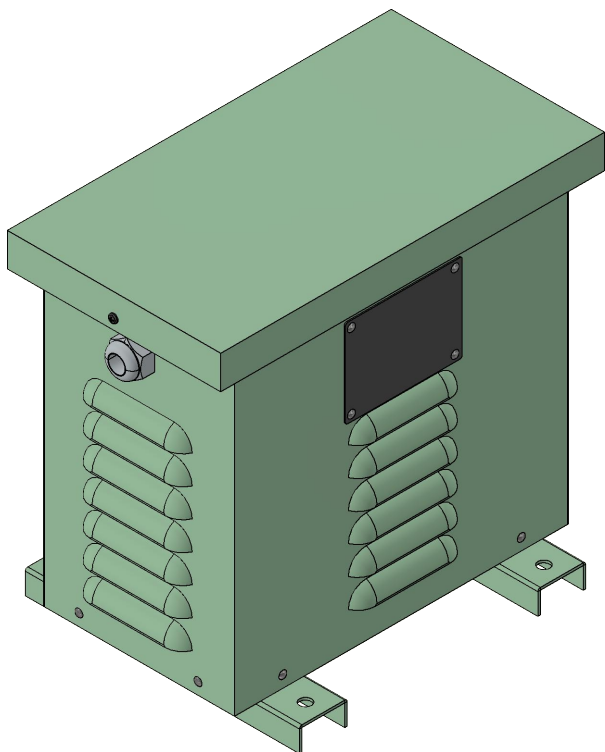
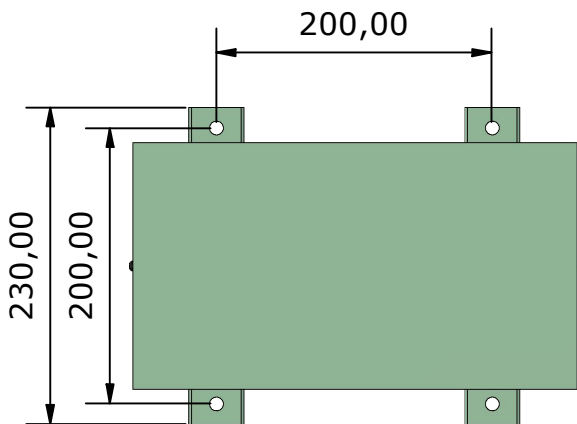
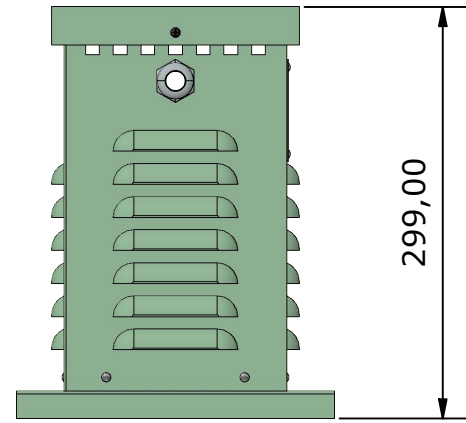

DATOS TECNICOS

Norma	EN-61.558-2-13
Potencia	3 KVA
Tension de entrada	400/690V+N
Tension de salida	400/690V+N
Frecuencia	50/60 Hz
Grado de proteccion	IP-23
Clase de Aislamiento	F
ED:	100%
Temperatura Ambiente	40°C
Clase	I
Rigidez Dielectrica entre Pri. y Sec.	-
Rigidez Dielectrica entre Pri. y masa	2.750V
Placa caract.	Si
Pantalla Electrostatica	No
Devanados	Hilo Aluminio G-2 clase H
Chapa Magnetica	Grano no orientado, laminada en frio. Calidad M 330-50A segun EN 10106
Carretes	PA6 + Fibra Vidrio (30%)
Tipo	Seco
Conexion	YN
Terminales	TEKOX 10mm
Peso	15 Kg.

Dibujado por: Miguel A. Hdez. - 27/03/2023

Aprobado por: Victor Gallego - 27/03/2023

AUTO-TRANSFORMADOR TRIFASICO



Units:
mm.

XMN02230963

Hoja 1 de 1
Rev: 01
Fecha Rev.: 27/03/2023

MANUMAG SL - C/Antonio Barriendos s/n, Pol. Ind. Las Norias
50450-MUEL, SPAIN - VAT ESB50040146
Tel +34 976 140606 - Fax +34 976 140 607
comercial@manumag.com, export@manumag.com



2

1