

2

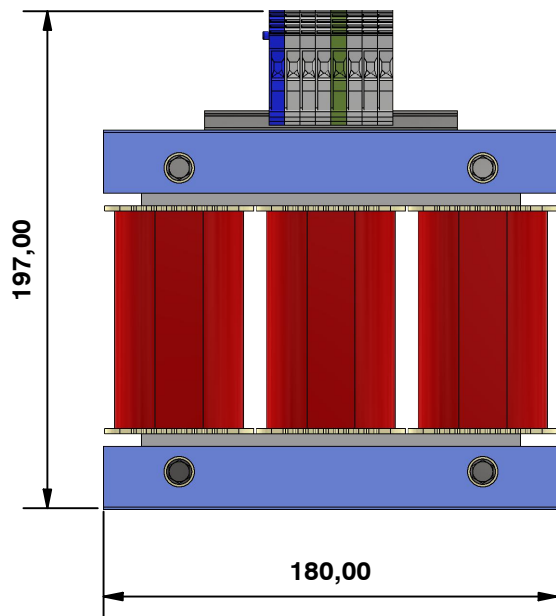

1

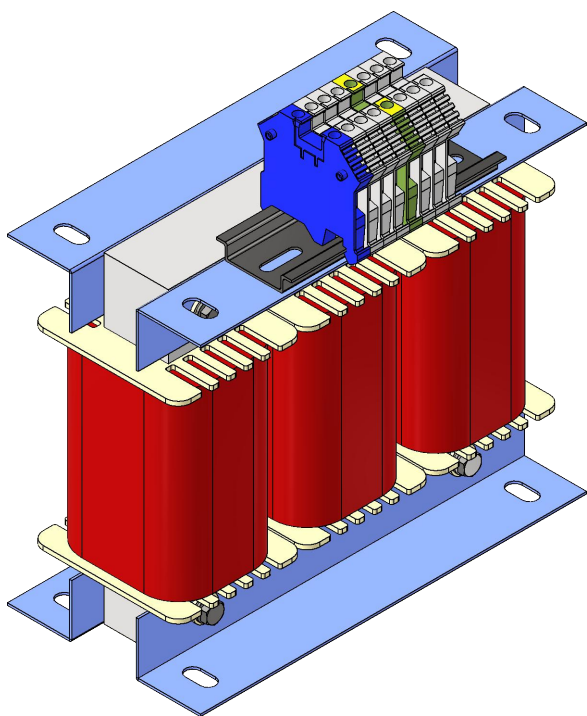
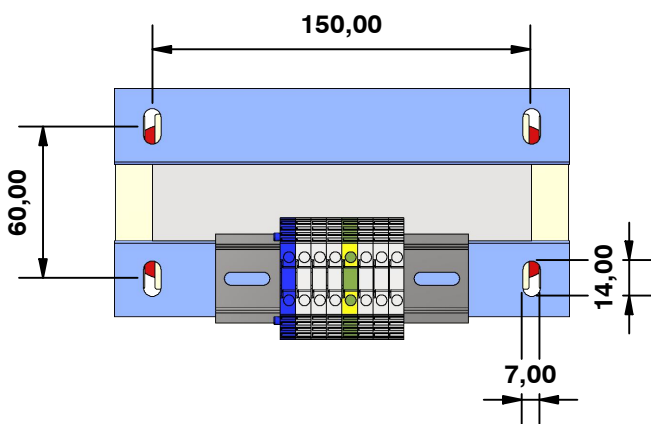
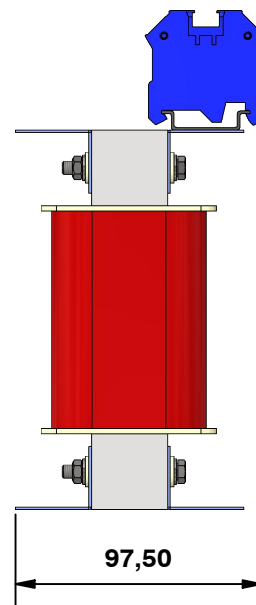

DATOS TECNICOS

Norma	EN-61.558-2-4
Potencia	500 VA
Tension de entrada	400V
Tension de salida	230V+N
Frecuencia	50/60 Hz
Grado de proteccion	IP-00
Clase de Aislamiento	F
ED:	100%
Temperatura Ambiente	40°C
Clase	I
Rigidez Dielectrica entre Pri. y Sec.	4.600V
Rigidez Dielectrica entre Pri. y masa	2.300V
Placa caract.	Si
Pantalla Electrostatica	No
Devanados	Hilo Cobre clase H
Chapa Magnetica	Grano no orientado, laminada en frio. Calidad M 330-50A SEGUN EN10106
Carretes	PA6 + Fibra Vidrio (30%)
Tipo	Seco
Conexion	Dyn
Terminales	CONTA CLIP 4mm (PRI) CONTA CLIP 4mm (SEC)
Peso	7 Kg.

Dibujado por:

Miguel A. Hdez. - 09/11/2023

Aprobado por:

Victor Gallego - 09/11/2023

TRANSFORMADOR TRIFASICO DE AISLAMIENTO

Units:
mm.

YA001505460

Hoja 1 de 1
Rev: 01
Fecha Rev.: 09/11/2023MANUMAG SL - C/Antonio Barriendos s/n, Pol. Ind. Las Norias
50450-MUEL, SPAIN - VAT ESB50040146 Tel +34 976 140606 - Fax +34 976 140 607
comercial@manumag.com, export@manumag.com

2

1